

MATERIAL

PuRity handles are made of a brand new material called PURA which is fully recyclable, 100% ecological, non-corrosive and anti-allergic. The unique BIOV or "Bioecologic Ion Overlay" process finishing is based on the deposition of gaseous metal ions, applied under vacuum. This coating is 100% ecological and recyclable which makes the handles extremely resistant against wear, very suited for aggressive environments and as an option even anti-bacterial. The combination of the material and surface treatment makes PuRity a sustainable handle!

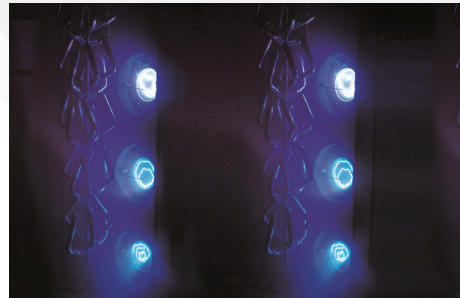

DESIGN

The PuRity range is fully adapted to the use- and design needs of constructors. The result is a minimal, classical and rational design that will give the Reynaers systems a unique touch.



INSTALLATION

We also provide the handles with their own unique new-generation mechanism, named Cliq-Claq. This mechanism slides over the square spindle of the doors or windows, and then snaps into place. Consequently, it ensures stronger fixation and allows the handle to return to the perfect position.



PURITY COLOURS

AVAILABLE COLOURS



Sapphire black
ref: LBMA



Eclipse
ref: BLMA



Moonlight white
ref: WHMA



Lithium
ref: STST

*in collaboration with ENTECH srl



1.1. WINDOWS

A. DESIGN HANDLE



Also available with
built-in cylinder lock
(ref. AA)

B. COMFORT HANDLE



Also available with
built-in cylinder lock
(ref. BB)

C. REDUCED HANDLE



D. DESIGN HANDLE OFFSET



E. COMFORT HANDLE OFFSET



A	161.7126.-- 161.7124.PC 161.7100.PC	✓		✓	✓	✓					✓				
AA	161.7103.PC		✓	✓		✓					✓	✓	✓	✓	✓
AA	161.7104.PC		✓		✓	✓					✓	✓	✓	✓	✓
B	161.7126.-- 161.7124.PC 161.7110.PC	✓		✓	✓	✓					✓				
BB	161.7113.PC		✓	✓		✓					✓	✓	✓	✓	✓
BB	161.7114.PC		✓		✓	✓					✓	✓	✓	✓	✓
C	061.7137.PC	✓		✓	✓	✓					✓				
D	161.7126.-- 161.7124.PC 161.7101.PC	✓		✓	✓	✓					✓				
E	161.7126.-- 161.7124.PC 161.7111.PC	✓		✓	✓	✓					✓				

Windows

Doors

Sliding doors

Lift and slide doors

Folding doors



1.2. DOORS

A. DESIGN HANDLE



Also available with a long cover plate (ref. AA)

B. COMFORT HANDLE



Also available with a long cover plate (ref. BB)

C. REDUCED HANDLE



D. DESIGN HANDLE OFFSET



Also available with a long cover plate (ref. DD)

E. COMFORT HANDLE OFFSET



ACCESSORIES

2-4-6 mm

F. PZ CYLINDER COVER



separate cylinder cover available with PuRity design in different dimensions and cylinder types

A	161.7125.-- 161.7124.PC 161.7100.PC	✓		✓	✓	✓	✓				✓				
AA	161.7369.PC 161.7100.PC		✓	✓		✓	✓				✓	✓	✓	✓	✓
AA	161.7370.PC 161.7100.PC		✓		✓	✓	✓				✓	✓	✓	✓	✓
B	161.7125.-- 161.7124.PC 161.7110.PC	✓		✓	✓	✓	✓				✓				
BB	161.7369.PC 161.7110.PC		✓	✓		✓	✓				✓	✓	✓	✓	✓
BB	161.7370.PC 161.7110.PC		✓		✓	✓	✓				✓	✓	✓	✓	✓
C*	161.7363.PC	✓		✓	✓	✓	✓				✓				
C*	161.7364.PC	✓		✓	✓	✓	✓				✓				
D	161.7125.-- 161.7124.PC 161.7101.PC	✓		✓	✓	✓	✓				✓				
DD	161.7369.PC 161.7101.PC		✓	✓		✓	✓				✓	✓	✓	✓	✓
DD	161.7370.PC 161.7101.PC		✓		✓	✓	✓				✓	✓	✓	✓	✓
E	161.7125.-- 161.7124.PC 161.7111.PC	✓		✓	✓	✓	✓				✓				
E	161.7369.PC 161.7111.PC		✓	✓		✓	✓				✓	✓	✓	✓	✓
E	161.7370.PC 161.7111.PC		✓		✓	✓	✓				✓	✓	✓	✓	✓
F	061.7146.PC		✓	✓	✓	✓	✓				✓				
F	061.7147.PC		✓	✓	✓	✓	✓				✓				
F	061.7148.PC		✓	✓	✓	✓	✓				✓				

*Not suited for Folding Door with door elements



1.3. SLIDING DOORS



A. DESIGN HANDLE



B. COMFORT HANDLE



C. DESIGN HANDLE OFFSET



D. COMFORT HANDLE OFFSET

ACCESSORIES

2-4-6 mm



E. PZ CYLINDER COVER

separate cylinder cover available with PuRity design in different dimensions and cylinder types

RZ Cylinder cover (ref. EE)

A	161.7226.-- 161.7124.PC 161.7100.PC	✓		✓	✓	✓	✓				✓				
B	161.7226.-- 161.7124.PC 161.7110.PC	✓		✓	✓	✓	✓				✓				
C	161.7226.-- 161.7124.PC 161.7101.PC	✓		✓	✓	✓	✓				✓				
D	161.7226.-- 161.7124.PC 161.7111.PC	✓		✓	✓	✓	✓				✓				
E	061.7146.PC		✓	✓	✓	✓	✓				✓	✓		✓	
E	061.7147.PC		✓	✓	✓	✓	✓				✓	✓		✓	
E	061.7148.PC		✓	✓	✓	✓	✓				✓	✓		✓	
EE	061.7127.PC		✓	✓	✓	✓	✓				✓	✓		✓	
EE	061.7128.PC		✓	✓	✓	✓	✓				✓	✓		✓	
EE	061.7129.PC		✓	✓	✓	✓	✓				✓	✓		✓	



1.4. LIFT AND SLIDE DOORS



A. DESIGN HANDLE



B. COMFORT HANDLE



C. RECESSED HANDLE

A	061.7105.PC		✓	✓	✓	✓	✓				✓				
A	061.7106.PC	✓		✓	✓	✓	✓				✓				
B	061.7115.PC		✓	✓	✓	✓	✓				✓				
B	061.7116.PC	✓		✓	✓	✓	✓				✓				
C	061.7112.PC	✓		✓	✓	✓	✓				✓				



1.5. FOLDING DOORS

PuRity window configurations can be applied on the CF range of folding window elements.

See windows section for full overview (page 4)

PuRity door configurations can be applied in the CF range of folding door elements.

See doors section for full overview (page 6)

A. REDUCED HANDLE



A	061.7138.PC	✓		✓	✓	✓	✓				✓				



2. CLASSIC LINE

SOMETHING FOR EVERYONE!

Reynaers Aluminium offers the Classic Line that is suitable for every style. The Classic handle line is a range of high quality products in terms of functionality and design. The Classic handles can be ordered in several finishing features.



TOUCH

Touch handles exude true elegance and fit into any type of architecture. Create an aesthetic look with this minimalist timeless design, tailored to the needs of contemporary living, without sacrificing ease of use.

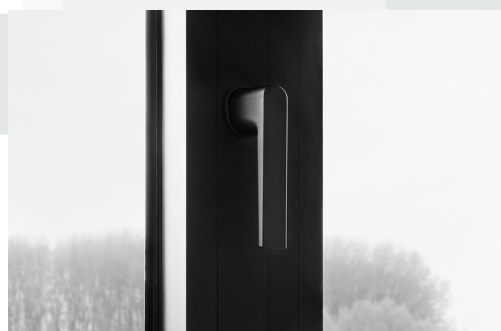

HORIZON

Horizon is a very modern handle in the Reynaers Aluminium range. The sleek design makes it ideal in combination with any type of window or door. The handle is characterised by the horizontal detail which gives it a very special effect.



SHIELD

Shield is our safest and strongest series of handles. Created to withstand thieves, these handles are characterized by their rugged, robust and reliable design. Shield received two SKG stars on most of the range and on some specific articles even three stars as a safety score.



ORCHID

Orchid is a beautiful and elegant series. These handles are very reliable and cost efficient. The series is characterized by the rounded design that radiates in its simplicity.



OLIMPO

The Olimpo line introduces an up-to-date design that meets the latest aesthetic trends. The smooth shape of the Olimpo line is enhanced by the many finishes available which contribute to meet the highest quality and aesthetic requirements.



ELEMENTRY

Elementry is a range of handles that is appropriate for other design solutions.



2.1. WINDOWS

**OUR WINDOW HANDLES
ARE AVAILABLE IN THE
FOLLOWING DESIGN
RANGES/LINES:**

- 2.1.1. Touch
- 2.1.2. Horizon
- 2.1.3. Shield
- 2.1.4. Orchid
- 2.1.5. Olimpo
- 2.1.6. Elementry

See page 11 for more information
about our different design lines





2.1.1. TOUCH

A. STANDARD HANDLE



Also available for
CF and outward
opening windows

B. ROSELESS HANDLE



Also available with
built-in cylinder lock
(ref. BB)

A	060.6455.XX	✓		✓	✓	✓		✓	✓						
A	060.6456.XX	✓		✓	✓	✓		✓	✓						
B	060.6450.PA	✓		✓	✓	✓			✓						
B	060.6451.XX	✓		✓	✓	✓		✓	✓						
BB	060.6452.XX		✓	✓	✓	✓		✓	✓			✓		✓	✓
BB	060.6453.XX		✓	✓		✓		✓	✓						
BB	060.6454.XX		✓		✓	✓		✓	✓						

2.1.2. HORIZON

A. STANDARD HANDLE

Also available for CF and outward opening windows



B. ROSELESS HANDLE

Also available with built-in cylinder lock (ref. BB)



A	061.6451.XX	✓		✓	✓	✓		✓	✓						
A	060.6543.XX	✓		✓	✓	✓		✓	✓						
B	061.6453.PA	✓		✓	✓	✓			✓						
BB	061.6454.XX		✓	✓	✓	✓		✓	✓			✓		✓	✓
BB	061.6463.XX		✓	✓		✓		✓	✓						
BB	061.6464.XX		✓		✓	✓		✓	✓						

2.1.3. SHIELD

A. STANDARD HANDLE



Also available with built-in cylinder lock (ref. AA)

A	061.6448.17	✓		✓	✓	✓		✓							
AA	060.6219.17		✓	✓	✓	✓		✓						✓	

2.1.4. ORCHID

A. STANDARD HANDLE

 Only compatible with Fapim gear

















Also available with built-in cylinder lock (ref. AA)

B. STANDARD HANDLE



Also available with built-in cylinder lock (ref. BB)

																
A	060.8900.PA	✓		✓	✓	✓			✓							
A	060.8851.PA	✓		✓	✓	✓			✓							
AA	060.8901.PA		✓	✓	✓	✓			✓							
B	060.8914.PA	✓		✓	✓	✓			✓							
BB	060.8915.PA		✓	✓	✓	✓			✓							



2.1.5. OLIMPO

A. ROSELESS HANDLE (IRIS)



Also available with built-in cylinder lock (ref. AA)

B. STANDARD HANDLE (EOS)



Also available with built-in cylinder lock (ref. BB)

C. STANDARD HANDLE (GEA)



Also available with built-in cylinder lock (ref. CC)

A	060.8588.XX	✓		✓	✓	✓		✓	✓						
AA	060.8589.PA		✓	✓	✓	✓			✓						
B	060.8586.XX	✓		✓	✓	✓		✓	✓						
BB	060.8587.XX		✓	✓	✓	✓		✓	✓						
C	060.8581.PA	✓		✓	✓	✓			✓						
C	060.8583.PA	✓		✓	✓	✓			✓						
CC	060.8582.PA		✓	✓	✓	✓			✓						
CC	060.8584.PA		✓	✓	✓	✓			✓						

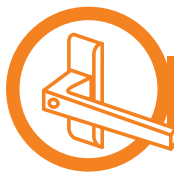

2.1.6. ELEMENTRY

A. STANDARD HANDLE



B. STANDARD HANDLE



C. STANDARD HANDLE FOR SOBINCO WINDOWGEAR



Also available with built-in cylinder lock (ref. CC)

D. STANDARD HANDLE FOR SOBINCO WINDOWGEAR



Also available with built-in cylinder lock (ref. DD)

E. STANDARD HANDLE FOR SOBINCO WINDOWGEAR



Also available with built-in cylinder lock (ref. EE)

F. STANDARD HANDLE FOR SIEGENIA WINDOWGEAR



Also available with built-in cylinder lock (ref. FF)

G. ROSELESS HANDLE FOR SIEGENIA WINDOWGEAR



Also available with built-in cylinder lock (ref. GG)

A	060.6190.XX	✓		✓	✓	✓		✓	✓	✓					
B	060.6191.XX	✓		✓	✓	✓		✓	✓	✓					
C	060.6050.PA	✓		✓	✓	✓			✓						
CC	060.6068.PA		✓	✓	✓	✓			✓					✓	
CC	060.6180.PA		✓		✓	✓			✓					✓	
CC	060.6182.PA		✓	✓		✓			✓					✓	
D	060.6070.PA	✓		✓	✓	✓			✓						
DD	060.6071.PA		✓	✓	✓	✓			✓					✓	
DD	060.6179.PA		✓		✓	✓			✓					✓	
DD	060.6181.PA		✓	✓		✓			✓					✓	
E	060.6049.XX	✓		✓	✓	✓		✓	✓						
EE	060.6067.XX		✓	✓	✓	✓		✓	✓					✓	
F	060.7213.PA	✓		✓	✓	✓			✓						
FF	060.7214.PA		✓	✓	✓	✓			✓						
G	060.7920.PA	✓		✓	✓	✓			✓						
GG	060.7921.PA		✓	✓	✓	✓			✓						

2.2. DOORS

**OUR DOOR HANDLES
ARE AVAILABLE IN THE
FOLLOWING DESIGN
RANGES/LINES:**

- 2.2.1. Touch
- 2.2.2. Horizon
- 2.2.3. Shield
- 2.2.4. Orchid
- 2.2.5. Olimpo

See page 11 for more information
about our different design lines





2.2.1. TOUCH

A. STANDARD HANDLE

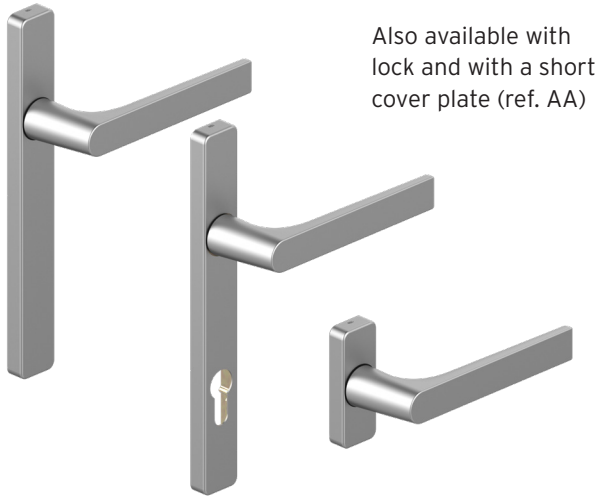

Also available with lock and with a short cover plate (ref. AA)

B. REDUCED HANDLE

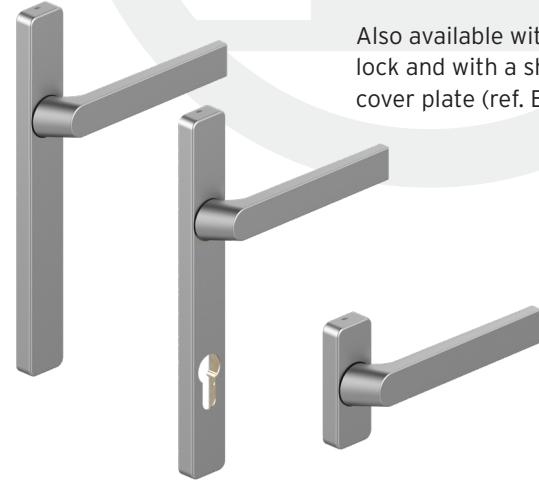

Also available with lock and with a short cover plate (ref. BB)

C. DOOR PULL

coming soon

D. COVER PLATE

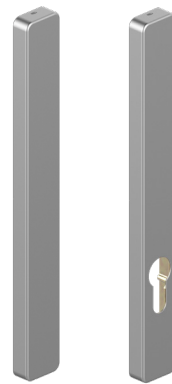

Also available with lock (ref. DD)

ACCESSORIES



E. CYLINDER COVER

Separate cylinder cover available for all Touch door handles.

A	061.6337.XX	✓		✓	✓	✓		✓	✓						
A	061.6338.XX	✓		✓	✓		✓	✓	✓						
A	061.6335.XX		✓	✓	✓	✓		✓	✓						
A	061.6336.XX		✓	✓	✓		✓	✓	✓						
AA	061.6330.XX	✓		✓	✓	✓		✓	✓						
AA	061.6331.XX	✓		✓	✓		✓	✓	✓						
B	061.6341.XX	✓		✓	✓	✓		✓	✓						
B	061.6342.XX	✓		✓	✓		✓	✓	✓						
B	061.6339.XX		✓	✓	✓	✓		✓	✓						
B	061.6340.XX		✓	✓	✓		✓	✓	✓						
BB	061.6332.XX	✓		✓	✓	✓		✓	✓						
BB	061.6333.XX	✓		✓	✓		✓	✓	✓						
D	061.6345.XX	✓		✓	✓	✓		✓	✓						
D	061.6346.XX	✓		✓	✓		✓	✓	✓						
DD	061.6343.XX		✓	✓	✓	✓		✓	✓						
DD	061.6344.XX		✓	✓	✓		✓	✓	✓						
E	061.6334.XX		✓	✓	✓	✓	✓	✓	✓						

F. SECURITY HANDLE



G. REDUCED SECURITY HANDLE



H. SECURITY COVER PLATE



F	061.6349.XX	✓		✓	✓	✓		✓	✓					✓	
F	061.6350.XX	✓		✓	✓		✓	✓	✓					✓	
F	061.6347.XX		✓	✓	✓	✓		✓	✓					✓	
F	061.6348.XX		✓	✓	✓		✓	✓	✓					✓	
G	061.6351.XX		✓	✓	✓	✓		✓	✓					✓	
G	061.6352.XX		✓	✓	✓		✓	✓	✓					✓	
G	061.6353.XX	✓		✓	✓	✓		✓	✓					✓	
G	061.6354.XX	✓		✓	✓		✓	✓	✓					✓	
H	061.6357.XX	✓		✓	✓	✓		✓	✓					✓	
H	061.6358.XX	✓		✓	✓		✓	✓	✓					✓	
H	061.6355.XX		✓	✓	✓	✓		✓	✓					✓	
H	061.6356.XX		✓	✓	✓		✓	✓	✓					✓	

2.2.2. HORIZON

A. STANDARD HANDLE



Also available with a short cover plate (ref. AA)

B. REDUCED HANDLE



Also available with a short cover plate (ref. BB)



C. DOOR PULL



D. COVER PLATE

ACCESSORIES



E. CYLINDER COVER

Separate cylinder cover available for all Horizon door handles.

A	061.7130.XX		✓	✓	✓	✓	✓	✓	✓						
A	061.7140.XX		✓	✓	✓		✓	✓	✓						
A	061.7480.XX		✓	✓	✓	✓		✓	✓					✓	
A	061.7481.XX		✓	✓	✓		✓	✓	✓					✓	
A	061.7131.XX	✓		✓	✓	✓		✓	✓						
A	061.7141.XX	✓		✓	✓		✓	✓	✓						
AA	061.7132.XX	✓		✓	✓	✓	✓	✓	✓						
AA	061.7142.XX	✓		✓	✓		✓	✓	✓						
B	061.7139.XX		✓	✓	✓		✓	✓	✓						
B	061.7149.XX	✓		✓	✓		✓	✓	✓						
BB	061.7136.XX	✓		✓	✓	✓		✓	✓						
B	061.7134.XX		✓	✓	✓	✓		✓	✓						
B	061.7144.XX		✓	✓	✓		✓	✓	✓						
B	061.7482.XX		✓	✓	✓	✓		✓	✓					✓	
B	061.7483.XX		✓	✓	✓		✓	✓	✓					✓	
B	061.7135.XX	✓		✓	✓	✓		✓	✓						
B	061.7145.XX	✓		✓	✓		✓	✓	✓						
BB	061.7133.XX	✓		✓	✓	✓	✓	✓	✓						
BB	061.7143.XX	✓		✓	✓		✓	✓	✓						
C	061.7485.XX		✓	✓			✓	✓	✓					✓	
C	061.7484.XX		✓		✓		✓	✓	✓					✓	
D	061.7486.XX		✓	✓	✓	✓		✓	✓					✓	
D	061.7487.XX		✓	✓	✓		✓	✓	✓					✓	
E	061.6992.XX		✓	✓	✓	✓	✓	✓	✓						



2.2.3. SHIELD



A. STANDARD HANDLE



B. REDUCED HANDLE



C. DOOR PULL



D. COVER PLATE

A	061.7434.XX		✓	✓	✓		✓	✓	✓					✓	
A	061.7441.XX		✓	✓	✓	✓		✓	✓					✓	
A	061.7460.XX		✓	✓	✓	✓		✓	✓					✓	
A	061.7461.XX		✓	✓	✓	✓		✓	✓					✓	
A	061.7462.XX		✓	✓	✓		✓	✓	✓					✓	
A	061.7414.XX		✓	✓	✓		✓	✓	✓					✓	✓
A	061.7435.XX	✓		✓	✓		✓	✓	✓					✓	
A	061.7442.XX	✓		✓	✓	✓		✓	✓					✓	
B	061.7436.XX		✓	✓	✓		✓	✓	✓					✓	
B	061.7443.XX		✓	✓	✓	✓		✓	✓					✓	
C	061.7430.XX		✓	✓			✓	✓	✓					✓	
C	061.7431.XX		✓		✓		✓	✓	✓					✓	
C	061.7439.XX		✓	✓	✓	✓		✓	✓					✓	
C	061.7463.XX		✓	✓	✓		✓	✓	✓					✓	
C	061.7411.XX		✓	✓	✓		✓	✓	✓					✓	✓
C	061.7432.XX	✓		✓			✓	✓	✓					✓	
C	061.7433.XX	✓			✓		✓	✓	✓					✓	
C	061.7440.XX	✓		✓	✓	✓		✓	✓					✓	
D	061.7438.XX		✓	✓	✓		✓	✓	✓					✓	
D	061.7444.XX		✓	✓	✓	✓		✓	✓					✓	
D	061.7437.XX	✓		✓	✓		✓	✓	✓					✓	

2.2.4. ORCHID



A. STANDARD HANDLE

ACCESSORIES

B. CYLINDER COVER
separate cylinder cover available for all door handles of Orchid

A	061.7229.PA	✓		✓	✓	✓	✓		✓						
A	060.8854.PA	✓		✓	✓	✓	✓		✓						
B	061.6976.PA		✓	✓	✓	✓	✓		✓						
B	060.8827.PA		✓	✓	✓	✓	✓		✓						

2.2.5. OLIMPO

A. DOOR HANDLE (HERA)



A	060.8585.XX	✓		✓	✓	✓	✓	✓	✓						

2.3. SLIDING DOORS

OUR SLIDING DOOR HANDLES ARE AVAILABLE IN THE FOLLOWING DESIGN RANGES/LINES:

- 2.3.1. Touch
- 2.3.2. Horizon
- 2.3.3. Shield
- 2.3.4. Orchid
- 2.3.5. Elementry

See page 11 for more information about our different design lines





2.3.1. TOUCH

A. STANDARD HANDLE

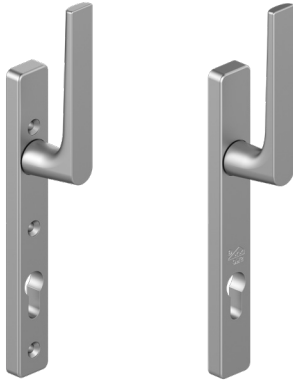

B. REDUCED HANDLE

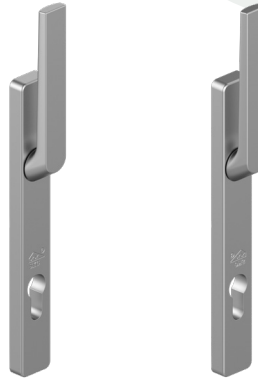

C. RECESSED HANDLE

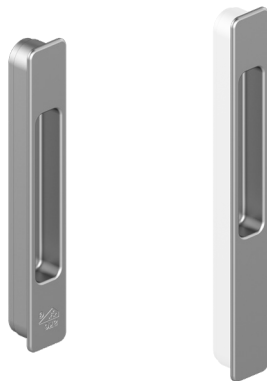

D. COVER PLATE

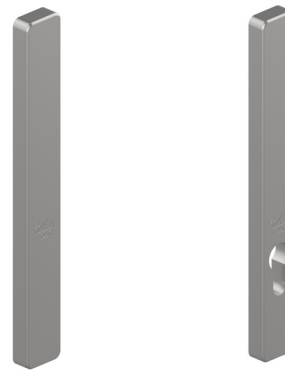

A	061.6360.XX		✓	✓	✓	✓		✓	✓					✓	
A	061.6361.XX		✓	✓	✓		✓	✓	✓					✓	
B	061.6362.XX		✓	✓	✓	✓		✓	✓					✓	
B	061.6363.XX		✓	✓	✓		✓	✓	✓					✓	
C	061.6364.XX	✓		✓	✓		✓	✓	✓					✓	✓
C	061.6370.XX	✓		✓	✓		✓	✓	✓						
D	061.6298.XX	✓		✓	✓		✓	✓	✓						
D	061.6296.XX		✓	✓	✓		✓	✓	✓						



2.3.2. HORIZON

Handles for handle operated locks



A. STANDARD HANDLE

Also available with a short cover plate (ref. AA)



B. REDUCED HANDLE

Also available with a short cover plate (ref. BB)

ACCESSORIES

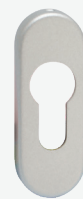

C. CYLINDER COVER
separate cylinder cover available for all door handles of Horizon

A	061.7130.XX		✓	✓	✓	✓	✓	✓	✓						
A	061.7140.XX		✓	✓	✓		✓	✓	✓						
A	061.7480.XX		✓	✓	✓	✓		✓	✓					✓	
A	061.7481.XX		✓	✓	✓		✓	✓	✓					✓	
A	061.7131.XX	✓		✓	✓	✓	✓	✓	✓						
A	061.7141.XX	✓		✓	✓		✓	✓	✓						
AA	061.7132.XX	✓		✓	✓	✓	✓	✓	✓						
AA	061.7142.XX	✓		✓	✓		✓	✓	✓						
B	061.7139.XX		✓	✓	✓		✓	✓	✓						
B	061.7149.XX	✓		✓	✓		✓	✓	✓						
B	061.7134.XX		✓	✓	✓	✓	✓	✓	✓						
B	061.7144.XX		✓	✓	✓		✓	✓	✓						
B	061.7135.XX	✓		✓	✓	✓	✓	✓	✓						
B	061.7145.XX	✓		✓	✓		✓	✓	✓						
BB	061.7136.XX	✓		✓	✓		✓	✓	✓						
BB	061.7133.XX	✓		✓	✓	✓	✓	✓	✓						
BB	061.7143.XX	✓		✓	✓		✓	✓	✓						
C	061.6992.XX		✓	✓	✓	✓	✓	✓	✓						



2.3.3. SHIELD

Handles for cylinder operated locks



**A. ROUNDED GRIP
- ROUND MODEL**



**B. ROUNDED GRIP
- U MODEL**



**C. ROUNDED GRIP
- STRAIGHT MODEL**



D. RECESSED HANDLE

A	061.7418.XX 061.7417.XX		✓	✓	✓	✓		✓	✓						
A	061.7419.XX 061.7417.XX	✓		✓	✓	✓		✓	✓						
A	061.7420.XX 061.7417.XX		✓	✓	✓		✓	✓	✓						
A	061.7421.XX 061.7417.XX	✓		✓	✓		✓	✓	✓						
B	061.7418.XX 061.7416.XX		✓	✓	✓	✓		✓	✓						
B	061.7419.XX 061.7416.XX	✓		✓	✓	✓		✓	✓						
B	061.7420.XX 061.7416.XX		✓	✓	✓		✓	✓	✓						
B	061.7421.XX 061.7416.XX	✓		✓	✓		✓	✓	✓						
C	061.7418.XX 061.7415.XX		✓	✓	✓	✓		✓	✓						
C	061.7419.XX 061.7415.XX	✓		✓	✓	✓		✓	✓						
C	061.7420.XX 061.7415.XX		✓	✓	✓		✓	✓	✓						
C	061.7421.XX 061.7415.XX	✓		✓	✓		✓	✓	✓						
D	061.7422.XX		✓	✓	✓		✓	✓	✓						
D	061.7423.XX	✓		✓	✓		✓	✓	✓						



2.3.4. ORCHID



A	062.7133.XX	✓		✓	✓		✓		✓						
B	062.7108.XX		✓	✓	✓	✓			✓						
C	062.7145.XX		✓	✓	✓		✓		✓						
D	062.7185.XX		✓	✓	✓	✓			✓						
D	062.7187.XX		✓	✓	✓		✓		✓						
E	062.7110.XX		✓	✓	✓	✓			✓						
F	062.7132.XX	✓		✓	✓		✓		✓						
G	062.7106	✓		✓	✓	✓			✓						

2.3.5. ELEMENTRY



A. ROUNDED GRIP - ROUND MODEL



B. ROUNDED GRIP - STRAIGHT MODEL



C. RECESSED HANDLE

A	062.7740.PA		✓	✓		✓			✓						
A	062.7741.PA		✓	✓			✓		✓						
A	062.7742.PA		✓		✓	✓			✓						
A	062.7743.PA		✓		✓		✓		✓						
A	062.7750.PA	✓		✓		✓			✓						
A	062.7751.PA	✓		✓			✓		✓						
A	062.7752.PA	✓			✓	✓			✓						
A	062.7753.PA	✓			✓		✓		✓						
B	062.7745.XX	✓		✓	✓	✓	✓	✓	✓						
C	062.7744.XX	✓		✓	✓	✓		✓	✓						

2.4. LIFT AND SLIDE DOORS

OUR LIFT AND SLIDE HANDLES ARE AVAILABLE IN THE FOLLOWING DESIGN LINES:

- 2.3.1. Touch
- 2.3.2. Horizon
- 2.3.3. Elementry

See page 11 for more information about our different design lines



2.4.1. TOUCH

A. STANDARD HANDLE

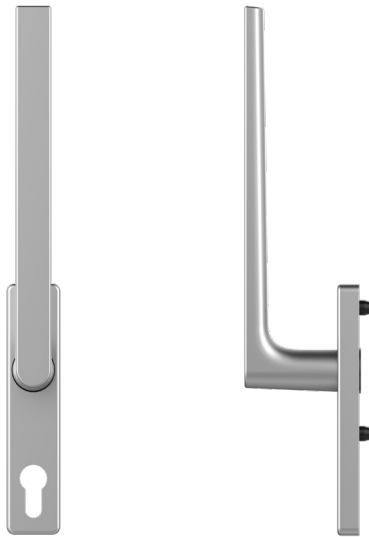

B. RECESSED HANDLE



A	061.6365.XX		✓	✓	✓	✓		✓	✓						
A	061.6366.XX		✓	✓	✓		✓	✓	✓						
A	061.6367.XX	✓		✓	✓	✓		✓	✓						
A	061.6368.XX	✓		✓	✓		✓	✓	✓						
B	061.6369.XX	✓		✓	✓		✓	✓	✓						



2.4.2. HORIZON



A. STANDARD HANDLE



B. RECESSED HANDLE

A	062.7766.XX	✓		✓	✓	✓	✓	✓						
A	062.7767.XX		✓	✓	✓	✓	✓	✓						
B	062.7768.XX	✓		✓	✓		✓	✓						



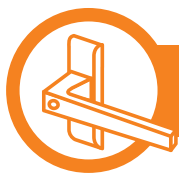

2.4.3. ELEMENTRY



A. STANDARD HANDLE



B. RECESSED HANDLE

A	062.7861.PA	✓		✓	✓	✓			✓						
A	062.7862.PA		✓	✓	✓	✓			✓						
A	062.7863.PA		✓	✓	✓		✓		✓						
A	062.7864.PA		✓	✓	✓	✓	✓		✓						
B	062.7872.PA	✓		✓	✓		✓		✓						



2.5. FOLDING DOORS



**OUR FOLDING DOOR
HANDLES ARE AVAILABLE
IN THE FOLLOWING DESIGN
LINES:**

- 2.5.1. Horizon
- 2.5.2. Shield
- 2.5.3. Orchid

See page 11 for more information
about our different design lines

